

Magnetic Catches

Part No.	Material	Finish	Holding Force lbf [N]
D418-05	die cast	satin nickel	approx. 12.1 [53.9]
D418-03	zinc plated		approx. 28.7 [127.5]

▶ steel, nickel plated magnet and keeper

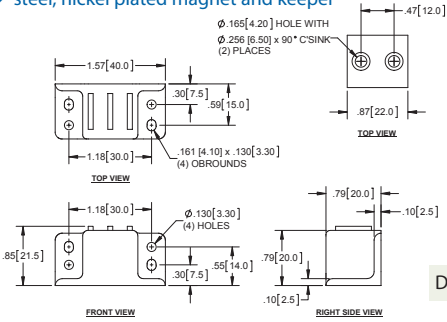

D418-05

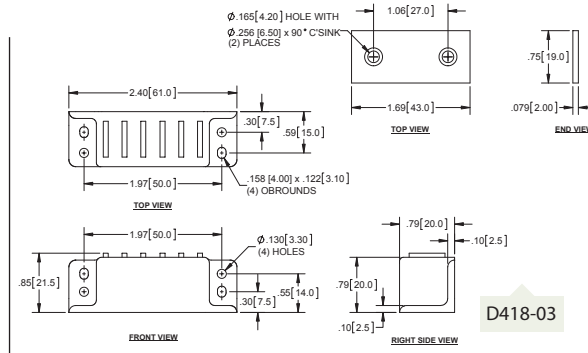

D418-03

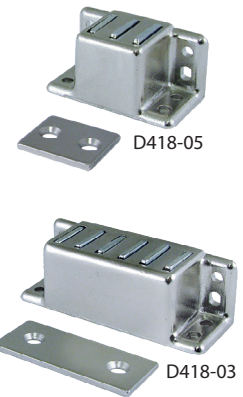

Magnetic Catch

Part No.	Material	Finish	Holding Force lbf [N]
D418-01	die cast zinc	satin nickel plated	approx. 33.1 [147.2]

▶ steel, nickel plated magnet and keeper

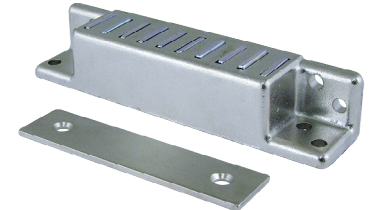
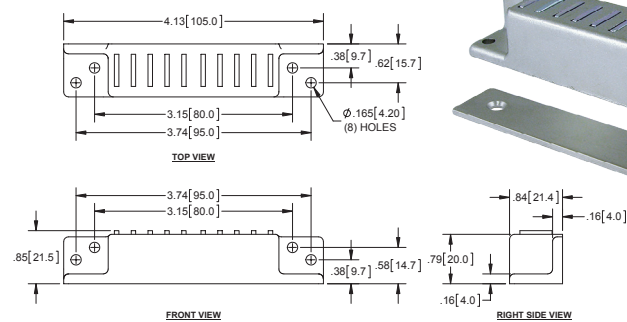
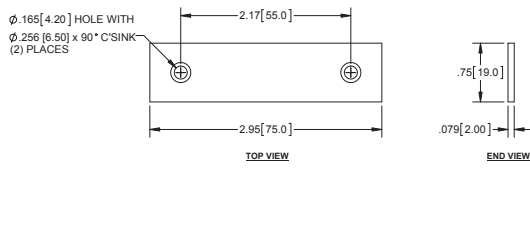

Toggle Latch

Part No.	Material	Finish
D434	plastic	black

▶ push to close and push to open

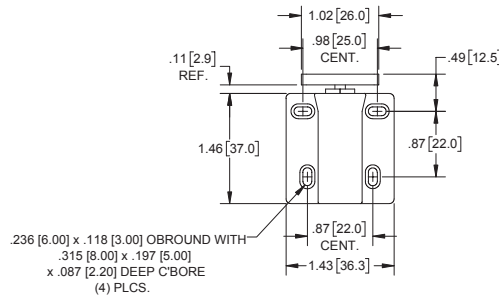

Roller Catch

Part No.	Material	Finish
D440	steel	zinc plated

▶ white polyethylene rollers

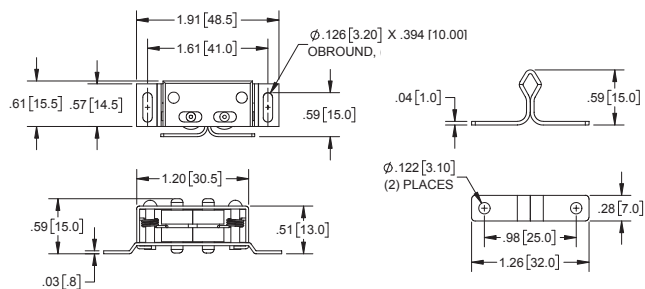

Roller Catch

Part No.	Material	Finish
D440SS-01	304SS	mill

▶ white polyethylene rollers

