

Cast Take-apart Enclosure Hinge

Part No.	Material	Finish
H2075	die cast zinc	black powder coated

▶ steel, zinc plated pins

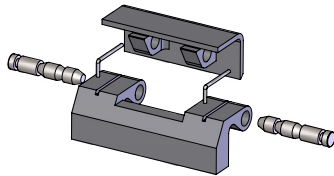

EXPLODED VIEW

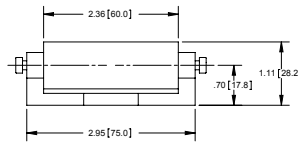

TOP VIEW

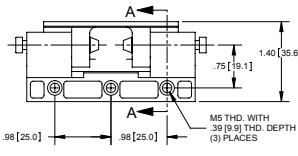

FRONT VIEW

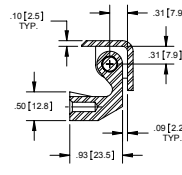

SECTION A-A



Take-apart Enclosure Hinge

Part Number	Base		Weld-on Leaf	
	Material	Finish	Material	Finish
H2086	die cast zinc	sand blasted	steel	zinc plated

▶ steel, zinc plated pin

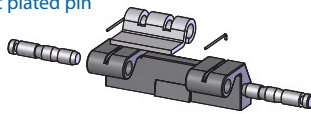

EXPLODED VIEW

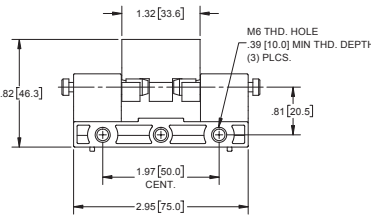
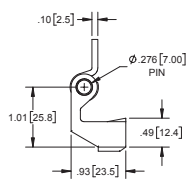

Enclosure Hinge

Part Number.	Material	Finish
H2267	steel	zinc plated

▶ steel clips and pins

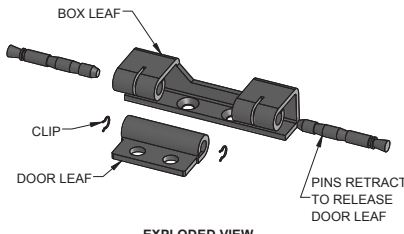

EXPLODED VIEW

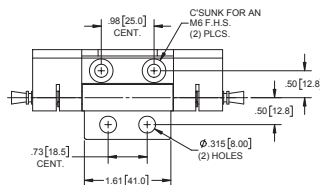

TOP VIEW

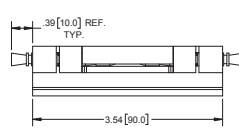

FRONT VIEW

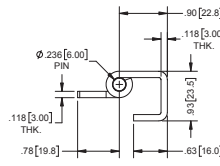

SIDE VIEW



Heavy Duty Hinges with Quick Release Pin

Part Number	Material	Finish
J2188	steel	zinc plated
J2188SS	304SS	passivated

▶ includes: box leaf, lid leaf, pin, capture ring

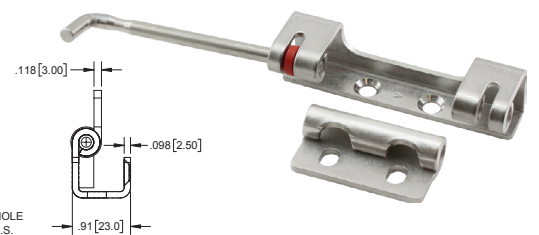
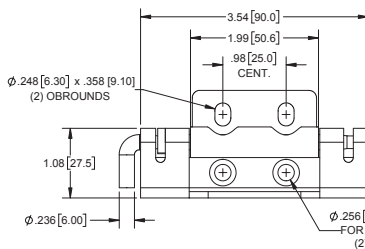

Enclosure Hinge Kits with Cast Box Leaves

Part Number	Box Leaf Material	Finish
J2130	die cast zinc	clear zinc
J2130SS	304SS	passivated

▶ includes: box leaf, lid leaf, pin, c-clip, (2) 1/4-20 screws, (2) sealing washers, (2) 1/4-20 nylon nuts

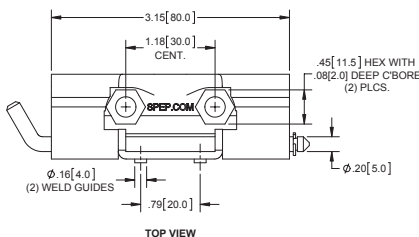

TOP VIEW

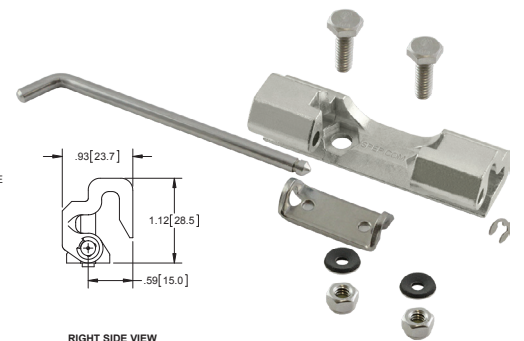

RIGHT SIDE VIEW