

Small Thermoplastic Draw Latches

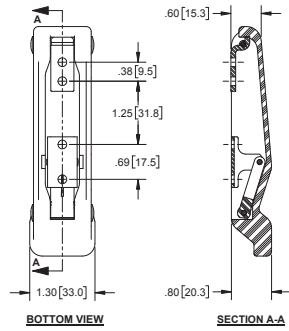

concealed right angle reversed



padlocking

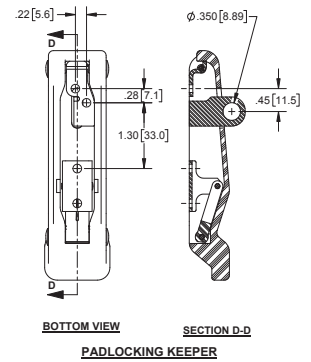
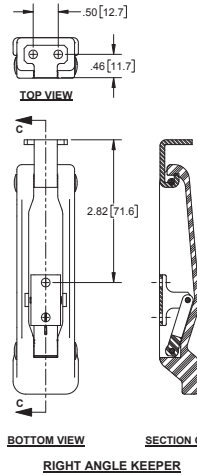
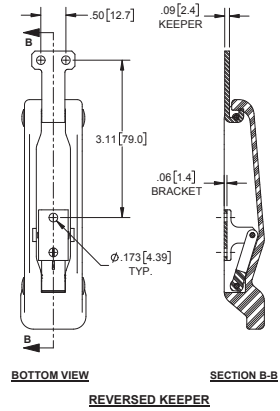

Part Number	Keeper Style
225-100SS	concealed
225-150SS	reversed
225-200SS	right angle
225-350SS	padlocking

- ▶ metal components are 304SS with passivated finish
- ▶ dimensions shown are after installation

Large Thermoplastic Draw Latches

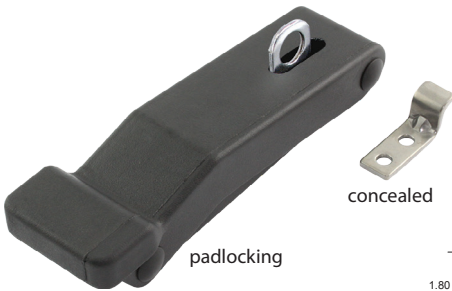

padlocking

concealed

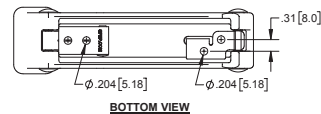
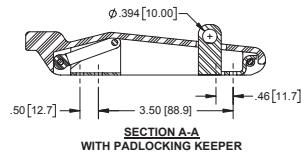
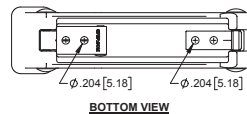
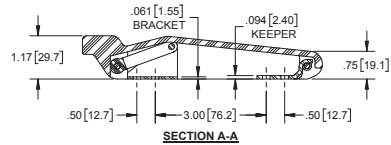
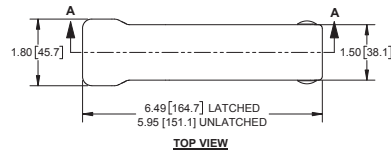

Part Number	Keeper Style
225-300SS	concealed
225-400SS	padlocking

- ▶ metal components are 304SS with passivated finish
- ▶ dimensions shown are after installation